

Powered Personal Transportation

-----SUPER 1000 WATT ELECTRIC SCOOTER-----

# OWNER'S MANUAL



**READ INSTRUCTIONS BEFORE USING YOUR NEW SCOOTER**

## TABLE OF CONTENTS

IMPORTANT INFORMATION .....	2-3
QUICK REFERENCE.....	4
GETTING TO KNOW YOUR SCOOTER.....	5
PACKAGE CONTENTS.....	6
GETTING STARTED.....	6
ASSEMBLY.....	6-7
FUSE INSTALLATION.....	7
SEAT&SEAT POST INSTALLATION.....	7
CHARGING.....	8
RIDING&BRAKING.....	8
FOLDING AND STORAGE.....	9
BRAKING SYSTEM.....	9
ADJUSTING BRAKES.....	9
TIRE PRESSURE.....	10
RECOMMENDED TOOLS.....	10
ADJUSTING THE HEAD UNIT.....	11
ADJUSTING THE CHAIN.....	11-12
MAINTENANCE SCHEDULE.....	12
TROUBLESHOOTING GUIDE.....	13
OTHER QUESTIONS.....	13

PLEASE BE SAFE WHEN RIDING

ALWAYS WEAR A HELMET AND OBEY ALL LAWS!



## BATTERY MAINTENANCE and CHARGING INSTRUCTIONS

1. You **MUST** charge completely prior to initial use. (Follow charging instructions in manual)
2. Charge immediately after each use.
3. Charge before storage. You must charge every 30 days if not in use.
4. Charge the unit for 6-8 hours or until the light on the charger turns red & green.
5. **DO NOT** allow this unit to deep discharge the battery.
6. For safety purposes, **DO NOT** charge for over 24 hours.
7. Turn the unit **OFF** when not in use.

**Failure to follow these INSTRUCTIONS will VOID YOUR WARRANTY!**

**This PRODUCT IS NOT INTENDED FOR EXTREME or OFF-ROAD Use! Please take care of your SCOOTER!**

**DO NOT JUMP or ABUSE THIS PRODUCT!**

**DO NOT RIDE IN WET/ICY CONDITIONS!**

Failure to follow these instructions will  
**VOID YOUR WARRANTY!**

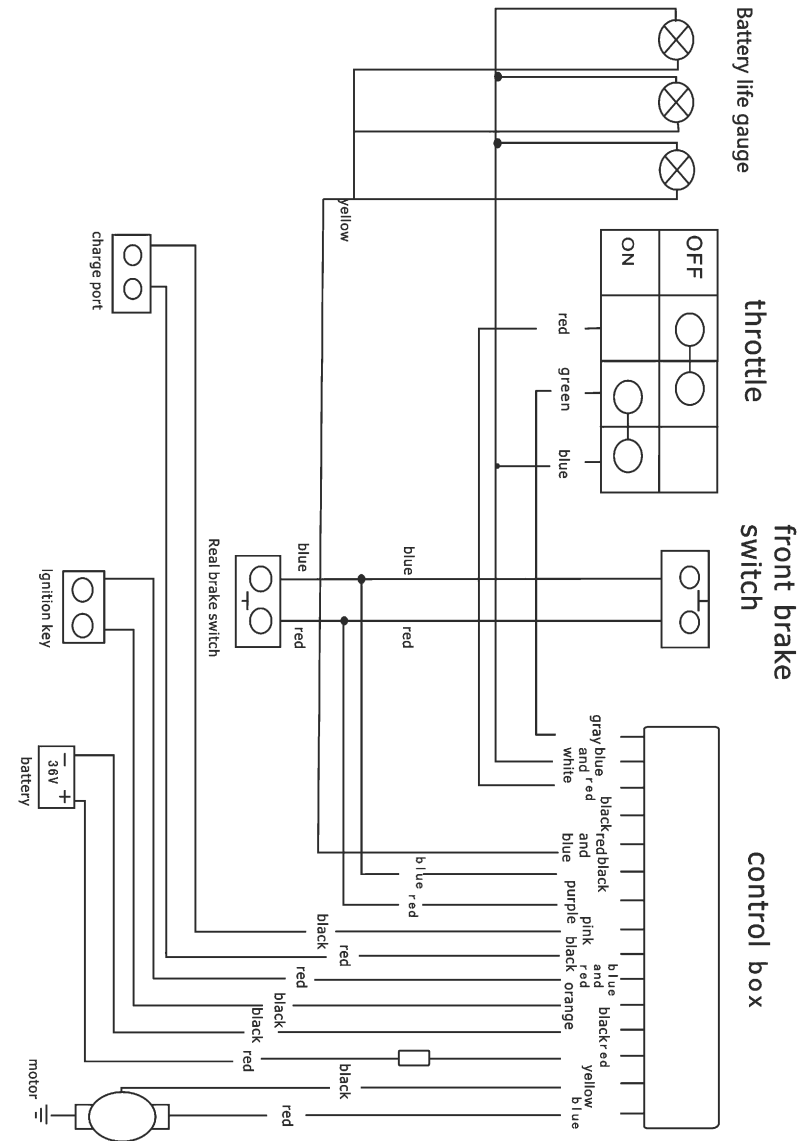

## SPECIFICATIONS AND FEATURE

Model Name		Super 1000W Electric scooter	
Lenght	1195mm	Motor Power	1000W
Width	615mm	Rated Speed	2830 RPM
Height	1110mm	Rated Current	29.8 AMP
Seat Height	760mm	Motor Voltage	DC 36V
Wheel Base	925mm	Max Speed	26-30 MPH
Max Load	115kgs	Front/Rear Brake	Disc/Disc
Battery	36V 14AH	Fuse	30AMP
Charge Time	6-8 hours	Drive Mode	Chain
Charge Voltage	AC100-240V	Pedal	ABS Resin
Tire Size	4.10/3.50-4	Folding	Yes
Tire Max Load	170KGS	Seat	Yes, Removable
Tire Max Pressure	40 P.S.I	Controller	DC 36V 1000W
Front Shock	Mono-Swinger Shock	Rear Shock	Double
Gross weight	44KGS	Net Weight	40KGS

## IMPORTANT

PLEASE READ THIS BEFORE USING THIS PRODUCT

**READ THIS FIRST!**

### WARNING

This product does not conform to Federal Motor Vehicle Standards and is not intended for operation on public streets, roads or highways. Serious injury can result from the unsafe operations of this product. Operator can minimize these risks by using certain safety equipment such as: safety helmet, goggles, gloves, elbow and kneepads and appropriate footwear.

DO NOT operate this product in traffic, on wet, frozen, oily or unpaved surfaces or under the influence of drugs and/or alcohol. Avoid uneven surfaces, potholes, surface cracks and obstacles.

DO NOT use a water hose to clean this product. See Product Handbook for more information.

This product is recommended for riders 16 YEARS OF AGE and older.

### SAFETY

- Persons without excellent vision, balance, coordination, reflex, muscle and bone strength and good decision-making capabilities should not use this product.
- Minors without adult supervision should not use this product.
- Persons unwilling or unable to take responsibility for their own actions should not use this product.
- The user of this product assumes ALL risks associated with its use. To minimize these RISKS, the user must wear safety helmet, goggles, gloves, elbow and kneepads and appropriate footwear.
- This product is ELECTRIC! DO NOT ride this product in wet conditions, puddles or rainy weather.

**QUICK REFERENCE  
SAFETY GUIDE**

**SAFETY GUIDE**

- The recommended minimum age for riding this scooter is 16 years old.
- To avoid damage to the motor and footplate, do not overload the scooter.
- Never ride with more than one person.
- Inspect your scooter thoroughly before each use for loose or missing parts.
- Avoid unintentional starts by turning the scooter off while not in use.
- To avoid the risk of a short circuit in the electrical parts, do not use your Electric scooter in the rain and never spray or wash off your scooter with water.
- Do not place the battery near fire or heat.
- To avoid damage to the battery, do not use the charger if it has been damaged in any way.
- Keep hands, face, feet and hair away from all moving parts.
- Do not touch the motor or wheels while they are rotating.
- Brakes are designed to control speed as well as stop the scooter. Practice braking for proper slowing down and smooth stops.
- Maintain your SCOOTER as recommended in this Product Handbook.
- Use only quality replacement parts as recommended by the manufacturer.
- Inspect the entire scooter prior to each use. Replace any part that is cracked, chipped or damaged before use.

**\*NEVER ALLOW CHILDREN TO OPERATE THE SCOOTER WITHOUT ADULT SUPERVISION.**

**\*NEVER ATTEMPT TO OPERATE THE SCOOTER WHILE UNDER THE INFLUENCE OF ALCOHOL.**

If a situation arises that is not covered in the manual,  
proceed with caution and use good judgment.

Contact your dealer  
if you need further assistance

SYMPTOMS	POTENTIAL CAUSE	SOLUTION
The charger light turns green & red right away.	<ol style="list-style-type: none"> <li>1. This indicates the batteries are adequately charged.</li> <li>2. Bad Fuse or open connection between charger socket and batteries.</li> </ol>	<ol style="list-style-type: none"> <li>1. Continue to charge the batteries for 6-8 hours prior to initial use.</li> <li>2. Check Fuse: Look for loose or disconnected wire.</li> </ol>
Batteries do not hold a charge. Unit does not have specified travel range.	<ol style="list-style-type: none"> <li>1. Batteries have reached the end of their useful life.</li> <li>2. Charger is malfunctioning.</li> </ol>	<ol style="list-style-type: none"> <li>1. Replace Batteries</li> <li>2. Replace Charger Unit.</li> </ol>
Unit moves intermittently or very slow.	<ol style="list-style-type: none"> <li>1. Batteries not fully charged.</li> <li>2. Loose Wire.</li> <li>3. Bad Throttle or controller.</li> </ol>	<ol style="list-style-type: none"> <li>1. Charge or replace batteries.</li> <li>2. Check for loose wires.</li> <li>3. Replace.</li> </ol>
Unit will not move when throttle lever is activated.	<ol style="list-style-type: none"> <li>1. Batteries not fully charged.</li> <li>2. Brake switches out of adjustment</li> <li>3. Batteries have reached the end of their useful life.</li> </ol>	<ol style="list-style-type: none"> <li>1. Replace batteries or charger.</li> <li>2. Loosen brakes.</li> <li>3. Replace batteries.</li> </ol>
Unit stops abruptly during use.	<ol style="list-style-type: none"> <li>1. Fuse Blown</li> <li>2. Loose or broken wire.</li> </ol>	<ol style="list-style-type: none"> <li>1. Replace Fuse</li> <li>2. Check for loose or broken wires and repair/replace.</li> </ol>

**OTHER QUESTIONS**

For additional questions, service instructions, further information ,please go to contact local dealer

Thank you for purchasing and please tell your friends how much fun you're having on the scooter

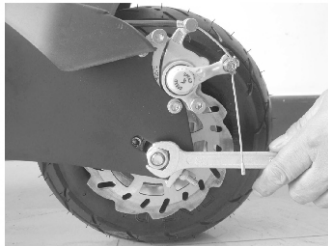

(FIG.19)

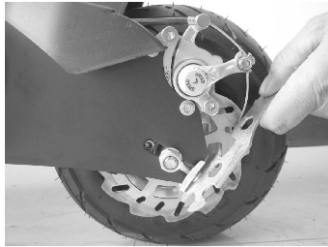

(FIG.20)

To tighten the chains:

Slightly loosen the two axle bolts on both sides of the rear wheel. Then slowly adjust the two adjusting screws on each side of the rear tire until chain reaches the proper tension.

Rotate the rear wheel to make sure the chain is aligned. Finally, lock and tighten the rear axle bolts prior to riding.

## MAINTENANCE SCHEDULE

Proper care of your scooter will insure optimal performance and longer life span. The following are a few maintenance suggestions that will keep your scooter running in top condition:

### Daily Maintenance

Perform each time you ride your scooter

- Clean the exterior of the unit with a soft, damp rag. (DO NOT WASH WITH A HOSE)
- Check that all nuts and bolts are securely tightened.
- Lubricate the chain with any silicone spray, 3&1 oil or any good clean motor oil.
- Check battery charger for any frayed/cut wires.

## GETTING TO KNOW YOUR SCOOTER

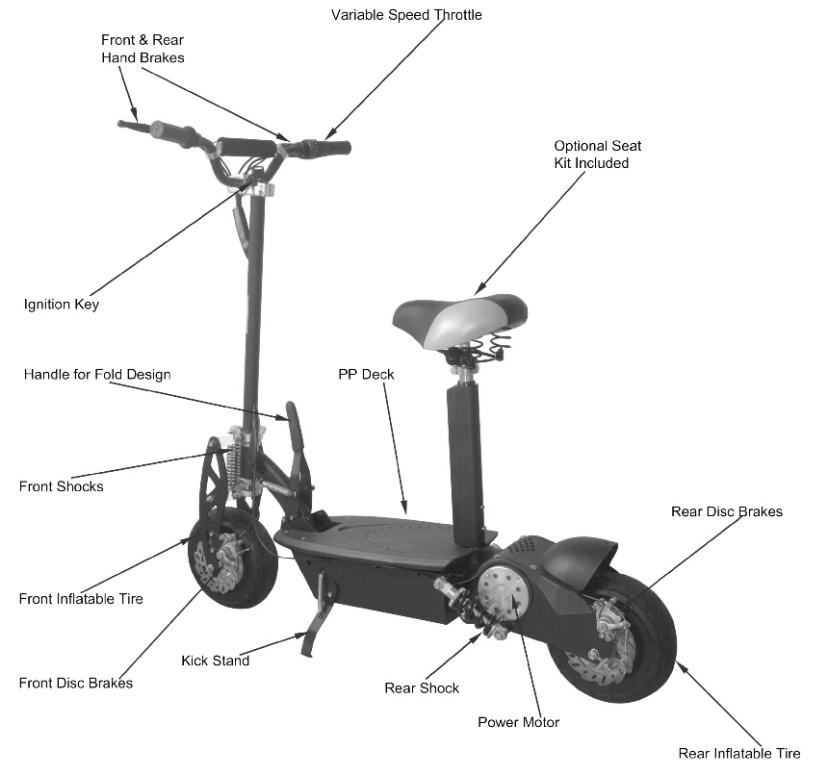



(Photo's may vary)

## PACKAGE CONTENTS

Your Scooter comes with the following items in the box. Please locate all of the following:

1. Scooter
2. 36V Battery Charger
3. Tool Kit User Manual and 30 amp Fuses
4. Seat
5. Seat Post & Clamp
6. Sticker

## GETTING STARTED

 Please read and understand these instructions and the **OPERATING PROCEDURES** section, prior to starting or riding your scooter 

### Assembly

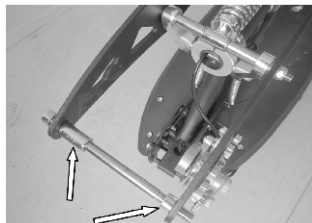

(FIG.1)

1. Carefully remove the scooter from the box. Then install the wheel ,longer spacer on the left and shorter spacer on the right,the wheel in the middle of both spacers,be sure to tightening screw.(FIG.1)

2. To unfold the scooter, begin by pressing down on the FOLDING HANDLE with one hand while gently pulling up on the handlebars with the other(FIG.2)

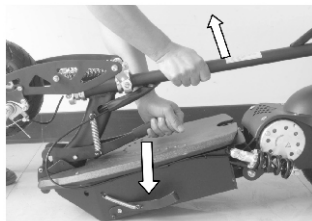

(FIG.2)

3. Fully extend the handlebars to their upright position until you feel the mechanism lock into place(FIG.3).

4. Adjust silver clamp to the top of handle bar post . Be sure to orient the bars in the correct riding position with the throttle on the rider's right side. Secure the handlebars to the post by tightening the bolts on the clamp with the enclosed Allen wrench as shown. (FIG.4,FIG.5)



(FIG.3)

5. Secure the hand brakes in place by using the provided Allen Wrench to first loosen the tension bolts. Adjust the levers to a comfortable position and tighten the bolts. **\*BE CAREFUL NOT TO PULL ON THE CABLES!**



(FIG.4)

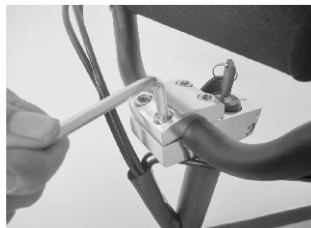

(FIG.5)

- Wrenches: 8/10/13/14/17 mm Open end wrench
- Large Adjustable Crescent Wrench
- Philips Head Screwdrivers
- Oil, Grease or Lubricant

## ADJUSTING THE HEAD UNIT

The head unit will come adjusted from the factory. However, riding on rough terrain and general use may cause the head unit to become loose over time. It may be necessary to adjust the head unit from time to time.



(FIG.18)

To adjust the head unit:

1. Rotate the handle bar as far right as it will go to expose the HEAD UNIT. (FIG.18)
2. Using a large adjustable wrench, gently turn the BEARING LOCK clockwise to tighten. **\*DO NOT OVER TIGHTEN OR IT WILL DAMAGE THE BEARINGS.**

## ADJUSTING THE CHAIN

The chain will come adjusted from the factory. However, it may be necessary to adjust the chain from time to time. The chain must be well aligned onto the sprockets in order to avoid uneven wear. This will result in shortened chain life.

### How tight should the chain be?

- If the chain is skipping or jumping on the sprockets, this is too loose and may be harmful.
- If the chain is making a humming sound when the wheel is turning, this is too tight and may cause the chain to snap.
- The correct tension is achieved by adjusting the chain from its loose position to when it becomes lightly tense.

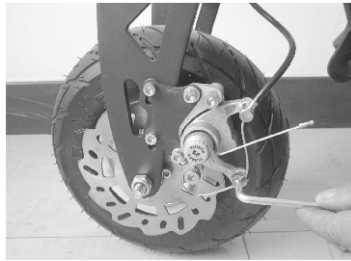

(FIG.16)

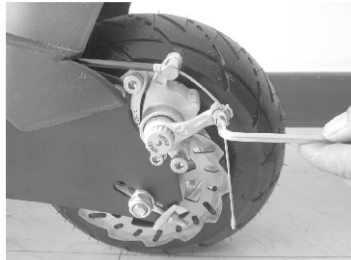

(FIG.17)

### **SQUEAKY BRAKES**

The brakes may squeak before they are broken in. This is normal and will not affect the function or performance of the brakes. With continued use the squeak should go away.

### **TIRE PRESSURE**

The tire must be inflated to a maximum of 40 P.S.I. It is also recommended to use a tube additive like **Slime**, available from any motorcycle shop, to avoid inconvenient punctures.

Empty all air from the tire, prior to loosening the bolt to split the rim.

### **MAINTENANCE**

#### **RECOMMENDED TOOLS**

To adjust and service the scooter you will need the following tools:

- Allen Wrenches: 3/4/5/6 mm

To adjust the front brakes:

For brakes that are adjusted too loose:

3. Adjust the tension screw on the left hand brake lever by rotating it counter-clockwise until the wheel spins freely.

For brakes that are adjusted too tight:

4. Tighten the tension screw on the left hand brake lever by rotating it clockwise until the wheel has a slight drag.

For Further Front Brake Adjustment

5. Locate the adjustment screw on the front brake assembly (located on the left of front wheel). Tighten or loosen as necessary.(FIG.16)

For Further Rear Brake Adjustment

6. Locate the adjustment screw on the rear brake assembly ( Located on the left of back wheel. Tighten or loosen as necessary.(FIG.17)

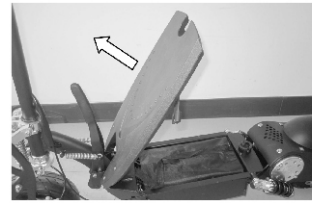

(FIG.6)

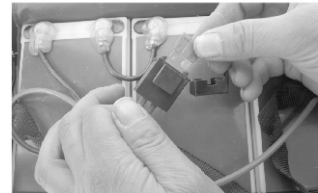

(FIG.7)

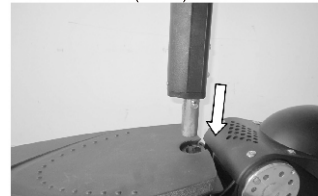

(FIG.8)

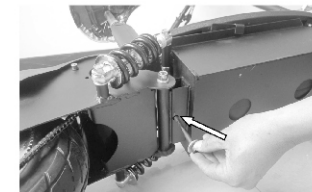

(FIG.9)



(FIG.11)

### **Assembly – Cont:**

6. Open outward metal lock at both side of PP deck and lift PP deck as shown.(FIG.6)
7. Insert the 30 amp fuse by opening the PP deck. Insert the fuse into the fuse holder ,then close PP deck. ( FIG.7 )
8. Attach the seat post to the seat post receiver.(FIG.8)
9. Insert the bolt into post holder on the bottom of frame.make sure to tightening the bolt.(FIG.9)
- 9-1. Insert the pin to secure the seat pole if you don't want to use the bottom bolt . (FIG.9-1)



(FIG.9-1)

10. Attach silver lock clamp to the top of the seat post as shown.(FIG.10)
- 11.Pull the upper seat post to the desired position and tighten the lock clamp securely.(FIG.11)
12. Attach the seat to the upper seat post and tightening the seat bolts as shown.(FIG.12)



(FIG.10)

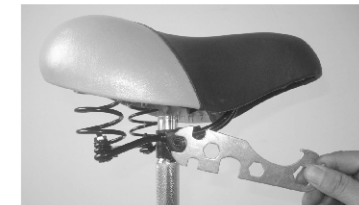

(FIG.12)



## **CHARGING**

Your scooter comes charged out of the carton. We still recommend charging the unit for 6-8 hours prior to it's first use. We also recommend charging your scooter after each use and prior to storage.

**WARNING:** DO NOT allow your scooter to go into deep discharge, as this will damage the batteries.



(FIG.13)

1. Make sure unit is turned off.
2. Open the charging socket cover located on the right side of the scooter frame, under the PP deck.
3. Locate your battery charger.(FIG.14)  
Find the charger socket end that has a three-prong socket and plug it into the scooter.(FIG.13)
4. Next, plug the AC plug into a wall outlet.



(FIG.14)

When first plugged in, the charger has one red light that will illuminate at the same time, indicating that the charging process has started. Once the light on the charger turns red & green, you may remove the charger and close the safety cap.

## **RIDING**

1. Make sure that all of the exposed bolts and screws are tightened.
2. Raise the kickstand to its upright position.
3. Put key switch to "ON", push the "on/off" switch (located on the right handlebar) to "ON".  
**(Please don't care it if there is no "on/off" switch on the right of handbar).**
4. Put one foot on the deck of the scooter while pushing off with the other foot, gently rotate the THROTTLE GRIP, on the right side of the handlebars. The scooter will begin to move on its own power.

\*\*Your scooter has a variable speed hand throttle. You can control the speed of your scooter by the amount of pressure you use when rotating the hand throttle. The more you rotate, the faster you will go.

## **STOPPING & BRAKING**

1. To brake, release the THROTTLE GRIP and depress the BRAKE LEVERS (on the left/right side of the handlebars). Depressing the brake will disengage power to the motor. When the unit feels like it is loosing power or not accelerating to full speed, the scooter is ready to be re-charged.

**NOTE:** If on/off switch in "ON" position more than 10-15 minutes without moving, smart power will shut itself off. To reset, turn switch "OFF", wait a few seconds, back "ON" again.

## **FOLDING & STORAGE**

When you are done riding the scooter you can fold it down for compact storage and transportation. First remove the seat post and seat, then using one hand, push down on the folding handle while gently pushing down on the handlebars. **BE CAREFUL NOT TO HIT YOUR HEAD WITH THE HANDLEBAR. SET YOURSELF AT THE RIGHT SIDE IS NECESSARY.** Push down until you feel the mechanism lock into the down position.(FIG.15)

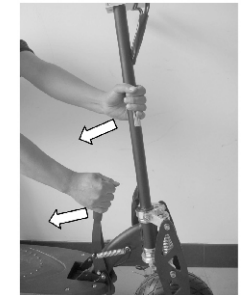

(FIG.15)

## **BRAKING SYSTEM**

The scooter is used disc/caliper braking system for the front and rear.They are both activated by a hand brake lever on the left and right side of the handlebar. Squeezing the hand brake lever with your left hand activates the rear brake. Squeezing the hand brake lever with your right hand activates the front brake. Make sure to release the **HAND THROTTLE GRIP** when engaging the brakes. Your scooter is equipped with switches on each brake lever that will disengage power to the motor when the brake levers are depressed.

Practice braking on a smooth, dry surface to get used to the feel of the braking system. Braking distance is affected by wet conditions and loose and uneven riding surfaces.

### **Adjusting the Brakes**

The Brakes on the scooter should come fully adjusted from the factory. However, it may be necessary to adjust the brakes from time to time.

To adjust the rear brakes:

For brakes that are adjusted too loose:

1. Adjust the tension screw on the right hand brake lever by rotating it counter-clockwise until the wheel spins freely.

For brakes that are adjusted too tight:

2. Tighten the tension screw on the right hand brake lever by rotating it clockwise until the wheel has a slight drag.